

KENWOOD

CD-RECEIVER

KDC-X589 KDC-MP5028 KDC-MP528

INSTRUCTION MANUAL

KENWOOD CORPORATION



AAC **PHATNOISE**



Take the time to read through this instruction manual. Familiarity with installation and operation procedures will help you obtain the best performance from your new CD-receiver. For your records

Record the serial number, found on the back of the unit, in the spaces designated on the warranty card, and in the space provided below. Refer to the model and serial numbers whenever you call upon your KENWOOD dealer for information or service on the product.

Model KDC-X589, KDC-MP5028, KDC-MP528

Serial number _____

Contents

Safety precautions	4	HD Radio control features	22
Notes	5	Tuning	
Warning	6	Menu system	23
About CDs	7	Menu System	
About AAC, MP3 and WMA	8	Security Code	
General features	9	Touch Sensor Tone	
Power		Manual Clock Adjustment	
Selecting the Source		DSI (Disabled System Indicator)	
Volume		Selectable Illumination	
Attenuator		Dimmer	
System Q		Switching preout	
Audio Control		Built-in Amp Setting	
Audio Setup		Dual Zone System Setting	
Subwoofer Output		B.M.S. (Bass Management System)	
Speaker Setting		B.M.S. Frequency Offset	
Switching Display		AMP Control	
Station/Disc Naming (SNPS/DNPS)		CRSC (Clean Reception System Circuit)	
Faceplate Angle Adjustment		Receive mode Setting	
Theft Deterrent Faceplate		SIRIUS ID (ESN) display	
TEL Mute		Auxiliary Input Display Setting & Station/Disc Naming	
Tuner features	15	Text Scroll	
Tuning		Built-in Auxiliary input Setting	
Tuning Mode		CD Read Setting	
Direct Access Tuning		Voice Index	
Station Preset Memory		ACDrive firmware version display	
Auto Memory Entry		Unique ID display	
Preset Tuning		Audio Preset Memory	
CD/Audio file/External disc control features	17	Audio Preset Call	
Playing CD & Audio file		Demonstration mode Setting	
Playing External Disc		Basic Operations of remote	30
Fast Forwarding and Reversing		Accessories/ Installation Procedure	32
Track/File Search		Connecting Wires to Terminals	33
Disc Search/Folder Search		Installation	34
Direct Track/File Search		Removing the Unit	36
Direct Disc Search		Troubleshooting Guide	37
Track/File/Disc/Folder Repeat		Specifications	40
Scan Play			
Random Play			
Magazine Random Play			
Disc Random Play			
Folder Select			
Switching the Play mode			
Letter Seek			
Text/Title Scroll			

The "AAC" logo is trademark of Dolby Laboratories.

Safety precautions

▲WARNING

To prevent injury or fire, take the following precautions:

- To prevent a short circuit, never put or leave any metallic objects (such as coins or metal tools) inside the unit.

Attach the panel while you are on the vehicle

The panel lock arm will be appeared when the panel is removed. Therefore, the panel must be attached during the driving.

▲CAUTION

To prevent damage to the machine, take the following precautions:

- Make sure to ground the unit to a negative 12V DC power supply.
- Do not install the unit in a spot exposed to direct sunlight or excessive heat or humidity. Also avoid places with too much dust or the possibility of water splashing.
- Do not set the removed faceplate or the faceplate case in areas exposed to direct sunlight, excessive heat or humidity. Also avoid places with too much dust or the possibility of water splashing.
- To prevent deterioration, do not touch the terminals of the unit or faceplate with your fingers.
- Do not subject the faceplate to excessive shock, as it is a piece of precision equipment.
- When replacing a fuse, only use a new one with the prescribed rating. Using a fuse with the wrong rating may cause your unit to malfunction.
- Do not apply excessive force to the open faceplate or place objects on it. Doing so will cause damage or breakdown.
- Do not use your own screws. Use only the screws provided. If you use the wrong screws, you could damage the unit.

Do Not Load 3-in. CDs in the CD slot

If you try to load a 3 in. CD with its adapter into the unit, the adapter might separate from the CD and damage the unit.

About CD players/disc changers connected to this unit

KENWOOD disc changers/ CD players released in 1998 or later can be connected to this unit.

Refer to the catalog or consult your Kenwood dealer for connectable models of disc changers/ CD players.

Note that any KENWOOD disc changers/ CD players released in 1997 or earlier and disc changers made by other makers cannot be connected to this unit. Unsupported connection may result in damage.

Setting the "O-N" Switch to the "N" position for the applicable KENWOOD disc changers/ CD players.

The functions that can be used and the information that can be displayed will differ depending on the models being connected.



- You can damage both your unit and the CD changer if you connect them incorrectly.

LX-bus connection

The LX AMP and the sensor unit cannot be connected simultaneously.

You must connect any of them at a time.

Lens Fogging

Right after you turn on the car heater in cold weather, dew or condensation may form on the lens in the CD player of the unit. Called lens fogging, CDs may be impossible to play. In such a situation, remove the disc and wait for the condensation to evaporate. If the unit still does not operate normally after a while, consult your Kenwood dealer.

NOTE

This Class B digital apparatus complies with Canadian ICES-003.

Notes

- If you experience problems during installation, consult your Kenwood dealer.
- If the unit fails to operate properly, press the Reset button. The unit returns to factory settings when the Reset button is pressed.
- Press the reset button if the disc auto changer fails to operate correctly. Normal operation should be restored.

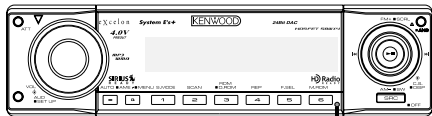

Reset button



Reset button

- We recommend the use of <Security Code> (page 24) to prevent theft.
- The characters which can be displayed by this unit are A-Z 0-9 @ " ' ` % & * + = , . / \ < > [] () ; : ^ - { } ~ .
- The illustrations of the display and the panel appearing in this manual are examples used to explain more clearly how the controls are used. Therefore, what appears on the display in the illustrations may differ from what appears on the display on the actual equipment, and some of the illustrations on the display may represent something impossible in actual operation.

Cleaning the Unit

If the faceplate of this unit is stained, wipe it with a dry soft cloth such as a silicon cloth.

If the faceplate is stained badly, wipe the stain off with a cloth moistened with neutral cleaner, then wipe neutral detergent off.



- Applying spray cleaner directly to the unit may affect its mechanical parts. Wiping the faceplate with a hard cloth or using a volatile liquid such as thinner or alcohol may scratch the surface or erase characters.

Cleaning the Faceplate Terminals

If the terminals on the unit or faceplate get dirty, wipe them with a dry, soft cloth.

Before using this unit for the first time

This unit is initially set on the Demonstration mode. When using this unit for the first time, cancel the <Demonstration mode Setting> (page 29).

About SIRIUS Satellite radio tuner

Refer to the instruction manual of SIRIUS Satellite radio tuner KTC-SR901/SR902/SR903 (optional accessory), when connected, for the operation method.

- Refer to the sections of A models for operations.

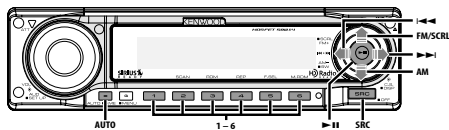
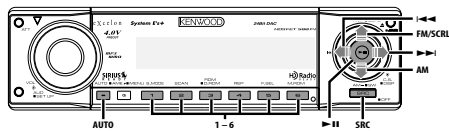

Notes

About DAB Tuner control

Refer to [A] group on the Instruction manual of DAB Tuner KTC-9090DAB (optional accessory) for the control method of DAB Tuner function.

However, the following control methods of the function for this unit may be differed from the Instruction manual; therefore, refer to the following supplemental instruction.

<Auto Ensemble Memory Entry>

1. Select the preset band for Auto Ensemble Memory Entry.
2. Press the [AME] button for at least 2 seconds. Open Auto Ensemble Memory Entry. After storing in the memory finishes, the number of the pre-set buttons and the ensemble label are displayed.

<Searching by programme type and language> and <Languages to be displayed> in <Programme Type (PTY) Function>

At the operation to press [DISP] button, press [AUTO] button.

About "Media Manager" of PC application attached to KDC-X589

- "Media Manager" is recorded in the CD-ROM attached to this unit.
- Refer to the attached installation manual for the installation method of "Media Manager".
- Refer to the user's manual recorded in the installation CD-ROM and Help of "Media Manager" for the operation method of "Media Manager".
- The unit can play CD (hereafter called "ACDrive disc") created by "Media Manager".
- Refer to the following site for the updated information of "Media Manager".
<http://www.kenwood.mediamanager.jp/>
- Contact Kenwood for the function and operation of the "Media Manager".
- "Media Manager" is a product of PhatNoise.

Warning

CAUTION

Use of controls or adjustments or performance of procedures other than those specified herein may result in hazardous radiation exposure. In compliance with Federal Regulations, following are reproductions of labels on, or inside the product relating to laser product safety.

KENWOOD CORPORATION
2967-3, ISHIKAWA-MACHI,
HACHIOJI-SHI
TOKYO, JAPAN

KENWOOD CORP. CERTIFIES THIS EQUIPMENT
CONFORMS TO DHHS REGULATIONS NO.21 CFR
1040. 10, CHAPTER 1, SUBCHAPTER J.

Location : Bottom Panel

FCC WARNING

This equipment may generate or use radio frequency energy. Changes or modifications to this equipment may cause harmful interference unless the modifications are expressly approved in the instruction manual. The user could lose the authority to operate this equipment if an unauthorized change or modification is made.

NOTE

This equipment has been tested and found to comply with the limits for a Class B digital device, pursuant to Part 15 of the FCC Rules. These limits are designed to provide reasonable protection against harmful interference in a residential installation. This equipment may cause harmful interference to radio communications, if it is not installed and used in accordance with the instructions. However, there is no guarantee that interference will not occur in a particular installation. If this equipment does cause harmful interference to radio or television reception, which can be determined by turning the equipment off and on, the user is encouraged to try to correct the interference by one or more of the following measures:

- Reorient or relocate the receiving antenna.
- Increase the separation between the equipment and receiver.
- Connect the equipment into an outlet on a circuit different from that to which the receiver is connected.
- Consult the dealer or an experienced radio/TV technician for help.

About CDs

Handling CDs

- Don't touch the recording surface of the CD.



- CD-R and CD-RW are easier to damage than a normal music CD. Use a CD-R or a CD-RW after reading the caution items on the package etc.
- Don't stick tape etc. on the CD. Also, don't use a CD with tape stuck on it.

When using a new CD

If the CD center hole or outside rim has burrs, use it after removing them with a ball pen etc.

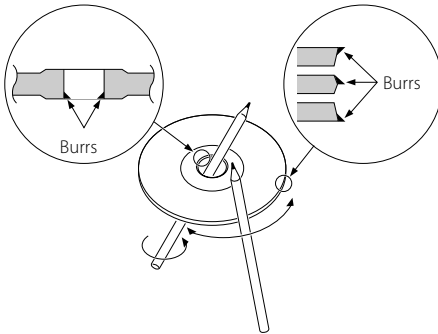

CD accessories

Don't use disc type accessories.

CD cleaning

Clean from the center of the disc and move outward.

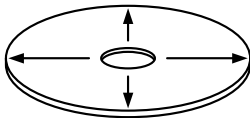

Removing CDs

When removing CDs from this unit pull them out horizontally.

CDs that can't be used

- CDs that aren't round can't be used.

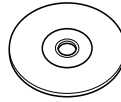

- CDs with coloring on the recording surface or that are dirty can't be used.
- This unit can only play the CDs with



It may not correctly play discs which do not have the mark.

- A CD-R or CD-RW that hasn't been finalized can't be played. (For the finalization process refer to your CD-R/CD-RW writing software, and your CD-R/CD-RW recorder instruction manual.)

CD storage

- Don't place them in direct sunlight (On the seat or dashboard etc.) and where the temperature is high.
- Store CDs in their cases.

About AAC, MP3 and WMA

The playable AAC/MP3/WMA file (hereafter called Audio file) and the media format has the following limitation. The Audio file, which is out of the specification, may not be able to be played normally, or the file and folder names may not be displayed correctly.



- Attach the correct extension for the Audio file (AAC: ".M4A", MP3: ".MP3", WMA: ".WMA")
- Do not attach the extensions to the other files besides the Audio file. If it is attached, the file, which is not the Audio file, will be played and outputs the loud noise, and then the speaker will be damaged.
- The files with copy protection cannot be played.

Playable AAC file

- ".m4a" file encoded by AAC-LC format.
Refer to <http://www.kenwood.mediamanager.jp/> for the details.

Playable MP3 file

- MPEG 1/2 Audio Layer 3 file
- Transfer bit rate: 8-320 kbps
- Sampling frequency
KDC-X589: 16, 22.05, 24, 32, 44.1, 48 kHz
KDC-MP5028/MP528: 8, 11.025, 12, 16, 22.05, 24, 32, 44.1, 48 kHz

Playable WMA file

- The file in accordance with Windows Media Audio (Except for the file for Windows Media Player 9 or after which applies the new functions)
- Transfer bit rate: 48-192 kbps
- Sampling frequency: 32, 44.1, 48 kHz

Playable media

- CD-ROM, CD-R, CD-RW



- Depending on the writing software, it may not be possible to use quick formatted CD-RW discs.
- When recording to the media up to the maximum capacity at once, the writing soft is set to "Disc at once".

Playable disc format

- ISO 9660 Level 1/2
- Joliet
- Romeo
- Long file name.

The maximum number of characters for display

File/Folder name:

KDC-X589: 128 characters

KDC-MP5028/MP528: 64 characters

MP3 ID3 Tag/ WMA Contents property/
AAC song information (KDC-X589 only): 30 characters



- File/Folder name is the number of the characters including the extensions.
- MP3 ID3 Tag can only display the tag of Ver1.X. (KDC-MP5028/MP528 only)
- AAC ID3 Tag cannot be displayed.

Limitation of structure for the file and the folder

- Maximum number of directory levels: 8
- Maximum number of folders: 100
- Maximum number of files per folder:
KDC-X589: 4096, KDC-MP5028/MP528: 255

Playing order of the Audio file

The Audio file is played in the order which is written by writing soft. You may be able to set the playing order by writing the play sequence numbers such as "01" to "99" at the beginning of the file name.

Example

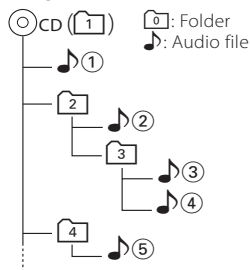

• Playing order

Playing order after ① play.

➡ ②, ③, ④, ⑤...

• File search

Forward file search during ③ play.

Push the Control knob to [▶▶] ➡ ④

• Folder search

Forward folder search during ② play.

Push the Control knob to [FM] ➡ ③, ④...

• Folder select

When it is set to directory ②, skip to the folder before the same level by folder select.

Push the Control knob to [◀◀] ➡ ②

When it is set to directory ③, makes the level up by folder select.

Push the Control knob to [AM] ➡ ②

General features

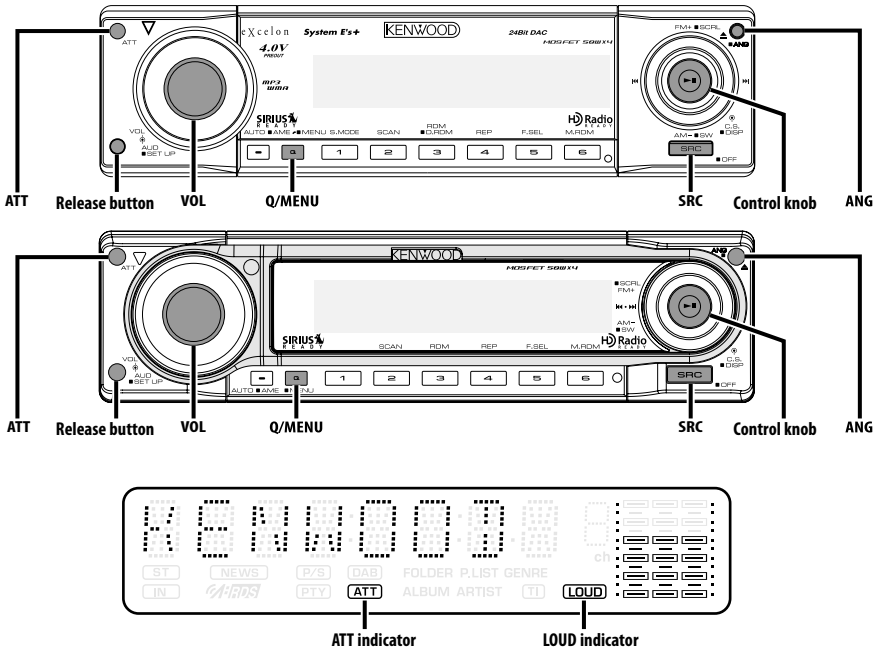

Power

Turning ON the Power

Press the [SRC] button.

Turning OFF the Power

Press the [SRC] button for at least 1 second.

Selecting the Source

Press the [SRC] button.

Source required	Display
SIRIUS tuner (Optional accessory)	"SIRIUS"
Tuner or HD Radio (Optional accessory)	"TUNER" or "HD RADIO"
CD	"CD"
External disc (Optional accessory)	"CD CH"
Auxiliary input*	"AUX"
Auxiliary input (Optional accessory)	"AUX EXT"
Standby (Illumination only mode)	"STANDBY"



- Function of the KDC-MP5028/MP528.

Volume

Increasing Volume

Turn the [VOL] knob clockwise.

Decreasing Volume

Turn the [VOL] knob counterclockwise.

Attenuator

Turning the volume down quickly.

Press the [ATT] button.

Each time the button is pressed, the Attenuator turns ON and OFF.

When it's ON, the "ATT" indicator blinks.

General features

System Q

You can recall the best sound setting preset for different types of music.

1 Select the source to set
Press the [SRC] button.

2 Select the Sound type
Press the [Q] button.

Each time the button is pressed, the sound setting switches.

Sound setting	Display
User memory	"USER"
Rock	"ROCK"
Pops	"POPS"
Easy	"EASY"
Top 40	"TOP40"
Jazz	"JAZZ"
Natural	"NATURAL"



- User memory: The values set on the <Audio Control> (page 10).
- Each setting value is changed with the <Speaker Setting> (page 12).
First, select the speaker type with the Speaker setting.

Audio Control

1 Select the source for adjustment
Press the [SRC] button.

2 Enter Audio Control mode
Press the [VOL] knob.

3 Select the Basic Audio item for adjustment
Press the [VOL] knob.

Each time the knob is pressed, the items that can be adjusted switch as shown below.

4 Adjust the Basic Audio item
Turn the [VOL] knob.

Adjustment Item	Display	Range
Rear Volume *1	"R-VOL"	0 — 35
Subwoofer level*2,3,4	"SW L"	-15 — +15
Bass level*5,6	"BAS L"	-8 — +8
Middle level*5,6	"MID L"	-8 — +8
Treble level*5,6	"TRE L"	-8 — +8
Balance	"BAL"	Left 15 — Right 15

Fader*4	"FAD"	Rear 15 — Front 15
Exit Audio Control mode	—	—



- *1 You can control this item when "2ZON" of <Audio Setup> (page 11) is set to "ON".
- *2 You can control this item when <Switching preout> (page 25) is set to "SWPRE SW". (KDC-MP5028/MP528 only)
- *3 You can control this item when <Subwoofer Output> (page 11) is set to "SW ON".
- *4 You can control this item when "2ZON" of <Audio Setup> (page 11) is set to "OFF".
- *5 These items can be adjusted in detail by the following methods. (Function of the KDC-X589)
- *6 Source tone memory: The set up value is put in the memory per source. (Detail Audio item is included)

5 Exit Audio Control mode

Press any button.

Press the button which is not [VOL] knob and [ATT]/ [ANG] button.

Adjust the detail of Audio Control

1 Select the Audio item for adjustment

By referring to the step 1 — 3 above, select the desired item to be set in detail from the items marked with *5.

2 Enter Detail adjustment mode of Audio Control

Press the [VOL] knob for at least 1 second.

3 Select the Detail Audio item for adjustment

Press the [VOL] knob.

Each time the knob is pressed, the items that can be adjusted switch as shown below.

4 Adjust the Detail Audio item

Turn the [VOL] knob.

Bass level

Adjustment Item	Display	Range
Bass Center Frequency	"BAS F"	40/50/60/70/80/100/120/150 Hz
Bass Q Factor	"BAS Q"	1.00/1.25/1.50/2.00
Bass Extend	"B EX"	OFF/ON

Middle level

Adjustment Item	Display	Range
Middle Center Frequency	"MID F"	0.5/1.0/1.5/2.0 kHz
Middle Q Factor	"MID Q"	1.0/2.0

Treble level

Adjustment Item	Display	Range
Treble Center Frequency	"TRE"	10.0/12.5/15.0/17.5 kHz

5 Exit the Detail Audio Control mode

Press the [VOL] knob for at least 1 second.



- When the Bass Extend is set to ON, low frequency response is extended by 20%.
- You can exit the Audio Control mode at anytime by pressing any button except for [VOL], [ATT] and [ANG] buttons.

Audio Setup

Setting the Sound system, such as Cross over Network.

1 Select the source for adjustment

Press the [SRC] button.

2 Enter Audio Setup mode

Press the [VOL] knob for at least 1 second.

3 Select the Audio Setup item for adjustment

Press the [VOL] knob.

Each time the knob is pressed, the items that can be adjusted switch as shown below.

4 Setup the Audio item

Turn the [VOL] knob.

Adjustment Item	Display	Range
Front High Pass Filter* ²	"HPF"	Through/40* ³ /60* ³ /80/100/ 120/ 150/180/220* ³ Hz
Rear High Pass Filter* ²	"HPR"	Through/40* ³ /60* ³ /80/100/ 120/ 150/180/220* ³ Hz
Low Pass Filter* ^{1,2}	"LPF"	50* ³ /60/80/100* ³ /120/ Through Hz
Subwoofer Phase* ^{1,2}	"PHAS"	Normal (0°) / Reverse (180°)
Volume offset	"V-OFF"	-8 — ±0
Loudness	"LOUD"	OFF/ON
Dual Zone System* ⁴	"2ZON"	OFF/ON



- Volume offset: Each source's volume can be set as a difference from the basic volume.
- Loudness: Compensating for low and high tones during low volume.
When it's ON, "LOUD" indicator is ON.
- *¹You can control this item when <Switching preout> (page 25) is set to "SWPRE SW". (Function of the KDC-MP5028/MP528)
- *¹ You can control this item when <Subwoofer Output> (page 11) is set to "SW ON".

- *² You can control this item when "2ZON" of <Audio Setup> (page 11) is set to "OFF".
- *³ KDC-X589/MP5028 only.
- *⁴ The Dual Zone System can be used with the Auxiliary input sources shown below.
 - Internal auxiliary input (KDC-MP5028/MP528 only)
 - Option CA-C1AX (KDC-X589 only)
- Dual Zone System
 - Main source and sub source (Auxiliary input) output Front channel and Rear channel separately.
 - The channel of sub source is set up by <Dual Zone System Setting> (page 25).
 - Main source is selected by [SRC] button.
 - The volume of Front channel is adjusted by [VOL] knob.
 - The volume of Rear channel is adjusted by <Audio Control> (page 10).
 - The Audio Control has no effect on sub source.

5 Exit Audio Setup mode

Press [VOL] knob for at least 1 second.

Subwoofer Output

Turning the Subwoofer output ON or OFF.

Hold down on [AM] of the Control knob for at least 1 second.

Each time the button is pressed, Subwoofer output switches ON and OFF.

When it's ON, "SW ON" is displayed.



- You can control this item when <Switching preout> (page 25) is set to "SWPRE SW". (KDC-MP5028/MP528 only)
- You can control this item when "2ZON" of <Audio Setup> (page 11) is set to "OFF".

General features

Speaker Setting

Fine-tuning so that the System Q value is optimal when setting the speaker type.

1 Enter Standby

Press the [SRC] button.

Select the "STANDBY" display.

2 Enter Speaker Setting mode

Press the [VOL] knob.

3 Select the Speaker type

Turn the [VOL] knob.

Each time the knob is turned, the setting switches as shown below.

Speaker type	Display
OFF	"SP OFF"
For 5 & 4 in. speaker	"SP 5/4"
For 6 & 6x9 in. speaker	"SP 6x9/6"
For the OEM speaker	"SP OEM"

4 Exit Speaker Setting mode

Press the [VOL] knob.

Switching Display

Switching the information displayed.

1 Enter Switching Display mode

Press the Control knob for at least 1 second.

"DISP SEL" is displayed.

2 Select the Display item

Push the Control knob to [◀◀] or [▶▶].

In Tuner source

Information	Display
Station name or Frequency	"SNPS"
Frequency	"FREQ"
Clock	"CLOCK"

In CD & External disc source

Information	Display
Disc title	"D-TITLE"*
Track title	"T-TITLE"*
Track number & Play time	"P-TIME"
Disc name	"DNPS"
Clock	"CLOCK"

In Audio file source

Information	Display
Song title & Artist name	"TITLE"*
Album name & Artist name	"ALBUM"*
Folder name	"FOLDER"
File name	"FILE"
Track number & Play time	"P-TIME"
Clock	"CLOCK"

In HD Radio source

Information	Display
Station name	"ST NAME"*
Song title / Artist name / Album name / Genre	"TITLE"*
Frequency	"FREQ"
Clock	"CLOCK"

In SIRIUS tuner source

Information	Display
Channel name	"CH NAME"
Song title	"SONG"
Artist name	"ARTIST"
Composer name	"COMPOSER"
Category name	"CATEGORY"
Label name	"LABEL"
Comment	"COMMENT"
Band & Channel number	"CH NUM"
Clock	"CLOCK"

In Auxiliary input source/ Standby source

Information	Display
Source name	"SRC NAME"
Clock	"CLOCK"

3 Exit Switching Display mode

Press the Control knob.



- When LX-AMP is connected, the item setup by the Display mode of LX-AMP is displayed. (KDC-X589 only)
- * If the contents of the information cannot be displayed, Play time or Frequency is displayed.
- Track number at Audio file displays the last 3 digits when it exceeds 1000 songs (KDC-X589 only).
- Album name cannot be displayed in WMA file. (KDC-MP5028/MP528 only)
- Song title, Artist name, and Album name cannot be displayed in AAC file. (KDC-MP5028/MP528 only)

- If the text for the Sirius tuner source, including Channel name, etc. is selected when the channel which does not have text for the Sirius tuner source, including Channel name, etc. is played, band & channel number is displayed.

Station/Disc Naming (SNPS/DNPS)

Attaching a title to a Station or CD.

1 Receive/play the station/disc you want to attach a title to



- A title can't be attached to MD or Audio file media.

2 Enter Menu mode

Press the [MENU] button for at least 1 second.

"MENU" is displayed.

3 Select Name set mode

Push the Control knob to [FM] or [AM].

Select the "NAME SET" display.

4 Enter Name set mode

Press the Control knob for at least 1 second.

5 Move the cursor to the enter character position

Push the Control knob to [◀◀] or [▶▶].

6 Select the characters

Push the Control knob to [FM] or [AM].



- Characters can be entered by using a remote with a numbers buttons.

Example: If "DANCE" is entered.

Character	Button	Times pressed
"D"	[3]	1
"A"	[2]	1
"N"	[6]	2
"C"	[2]	3
"E"	[3]	2

7 Repeat steps 5 through 6 and enter the name.

8 Exit Menu mode

Press the [MENU] button.



- When operation stops for 10 seconds the name at that time is registered, and Name Set mode closes.

- Memory numbers
 - Tuner: 30 stations
 - Internal CD player: 10 discs
 - External CD changer/ player: Varies according to the CD changer/ player manual.
- The title of station/CD can be changed by the same operation used to name it.

Faceplate Angle Adjustment

Press the [ANG] button for at least 1 second.



- Do not apply excessive force to the faceplate. It can cause damage.

General features

Theft Deterrent Faceplate

The faceplate of the unit can be detached and taken with you, helping to deter theft.

Removing the Faceplate

Press the Release button.

The faceplate is unlocked, allowing you to detach it.

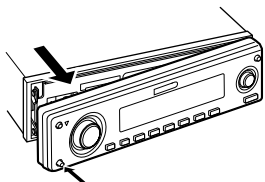

- The faceplate is a precision piece of equipment and can be damaged by shocks or jolts. For that reason, keep the faceplate in its special storage case while detached.
- Do not expose the faceplate or its storage case to direct sunlight or excessive heat or humidity. Also avoid places with too much dust or the possibility of water splashing.

Reattaching the Faceplate

1 Align the shaft on the unit with the depression on the faceplate.

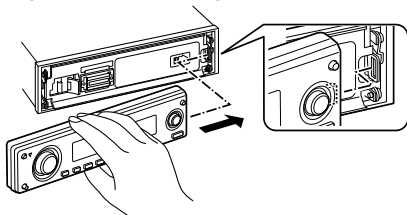

2 Push the faceplate in until it clicks.

The faceplate is locked in place, allowing you to use the unit.

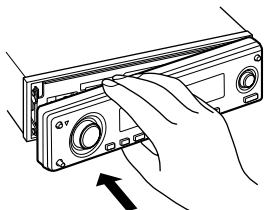

TEL Mute

The audio system automatically mutes when a call comes in.

When a call comes in

"CALL" is displayed.

The audio system pauses.

Listening to the audio during a call

Press the [SRC] button.

The "CALL" display disappears and the audio system comes back ON.

When the call ends

Hang up the phone.

The "CALL" display disappears and the audio system comes back ON.

Tuner features

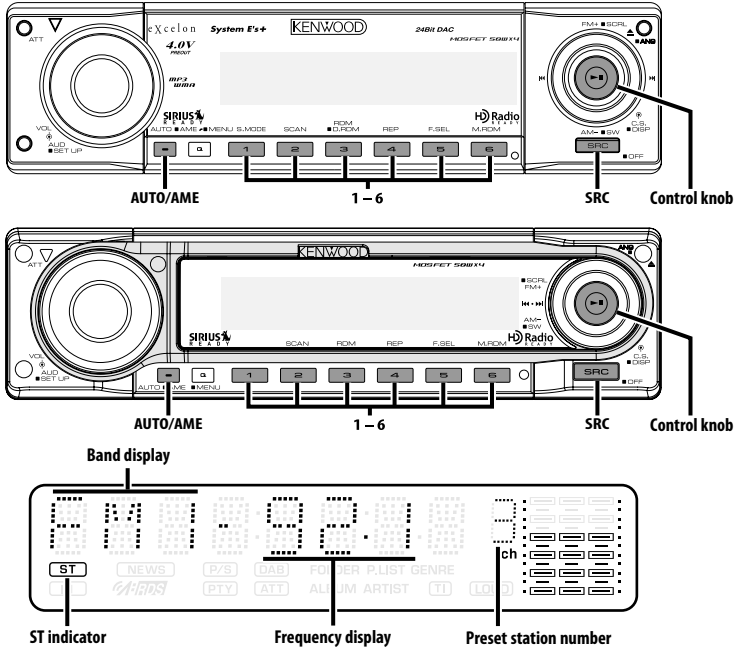

Tuning

Selecting the station.

1 Select tuner source

Press the [SRC] button.

Select the "TUNER" display.

2 Select the band

Push the Control knob to [FM] or [AM].

Each time the knob is pushed to [FM], it switches between the FM1, FM2, and FM3 bands.

3 Tune up or down band

Push the Control knob to [◀◀] or [▶▶].



- During reception of stereo stations the "ST" indicator is ON.

Tuning Mode

Choose the tuning mode.

Press the [AUTO] button.

Each time the button is pressed, the Tuning mode switches as shown below.

Tuning mode	Display	Operation
Auto seek	"AUTO 1"	Automatic search for a station.
Preset station seek	"AUTO 2"	Search in order of the stations in the Preset memory.
Manual	"MANUAL"	Normal manual tuning control.

Tuner features

Function of remote

Direct Access Tuning

Entering the frequency and tuning.

1 Select the band

Press the [FM] or [AM] button.

2 Enter Direct Access Tuning mode

Press the [DIRECT] button on the remote.

"- - - -" is displayed.

3 Enter the frequency

Press the number buttons on the remote.

Example:

Desired frequency	Press button
92.1 MHz (FM)	[0], [9], [2], [1]
810 kHz (AM)	[0], [8], [1], [0]

Canceling Direct Access Tuning

Press the [DIRECT] button on the remote.

Station Preset Memory

Putting the station in the memory.

1 Select the band

Push the Control knob to [FM] or [AM].

2 Select the frequency to put in the memory

Push the Control knob to [◀◀] or [▶▶].

3 Put the frequency in the memory

Press the desired [1] — [6] button for at least 2 seconds.

The preset number display blinks 1 time.

On each band, 1 station can be put in the memory on each [1] — [6] button.

Auto Memory Entry

Putting stations with good reception in the memory automatically.

1 Select the band for Auto Memory Entry

Push the Control knob to [FM] or [AM].

2 Open Auto Memory Entry

Press the [AME] button for at least 2 seconds.

When 6 stations that can be received are put in the memory Auto Memory Entry closes.

Preset Tuning

Calling up the stations in the memory.

1 Select the band

Push the Control knob to [FM] or [AM].

2 Call up the station

Press the desired [1] — [6] button.

CD/Audio file/External disc control features

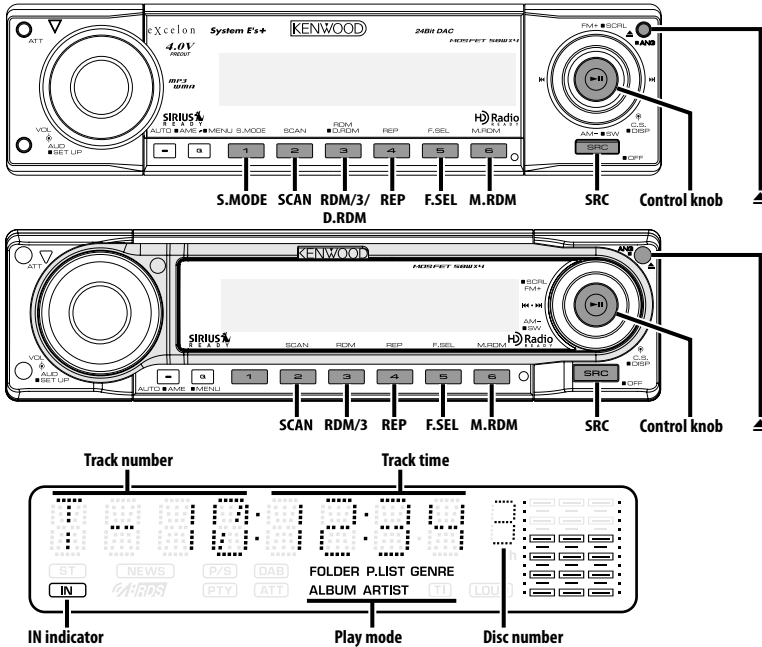

Playing CD & Audio file

When there is no disc inserted

- 1 Open the panel.
Press the [▲] button.
- 2 Insert a disc.



- When the faceplate has been slid open, it might interfere with the shift lever or something else. If this happens, pay attention to safety and move the shift lever or take an appropriate action, then operate the unit.
- Insert the disc horizontal to the slot. If you insert the Disc as you push down the Disc, it may scratch the Disc.



- Refer to <About AAC, MP3 and WMA> (page8) for the Audio file by models which can be played.
- The announcement when selecting the folder can be canceled by <Voice Index> (page28) during the play of the ACDrive.
- When a disc is inserted the "IN" indicator is ON.

When a disc is inserted

- Press the [SRC] button.
Select the "CD" display.

Pause and play

- Press the Control knob.
Each time the knob is pressed, it pauses and plays.

Eject the disc

- 1 Eject the disc
Press the [▲] button.
- 2 Return the panel to the original position
Press the [▲] button.

CD/Audio file/External disc control features

Playing External Disc

Playing discs set in the optional accessory disc player connected to this unit.

Press the [SRC] button.

Select the display for the disc player you want.

Display examples:

Display	Disc player
"CD CH"	CD changer
"MD CH"	MD changer

Pause and play

Press the Control knob.

Each time the knob is pressed, it pauses and plays.



- Disc 10 is displayed as "0".
- The functions that can be used and the information that can be displayed will differ depending on the external disc players being connected.

Fast Forwarding and Reversing

Fast Forwarding

Hold down on [▶▶] of the Control knob.

Release your finger to play the disc at that point.

Reversing

Hold down on [◀◀] of the Control knob.

Release your finger to play the disc at that point.



- The sound is not output while the Audio file is being searched.
- Fast Forwarding and Reversing cannot be done while AAC is being played. (KDC-MP5028/MP528 only)
- Fast Forwarding and Reversing cannot be done depending on AAC file format. (KDC-X589 only)

Track/File Search

Searching for a song on the disc or in the Audio file folder.

Push the Control knob to [◀◀] or [▶▶].

Function of disc changer/ Audio file

Disc Search/Folder Search

Selecting the disc set in the Disc changer or the folder recorded on the Audio file media.

Push the Control knob to [FM] or [AM].

Function of remote

Direct Track/File Search

Doing Track/File Search by entering the track/file number.

1 Enter the track/file number

Press the number buttons on the remote.



- Direct File Search can be selected up to 999. (KDC-X589 only)

2 Do Track/File Search

Press the [◀◀] or [▶▶] button.

Canceling Direct Track/File Search

Press the [▶II] button.

Function of disc changers with remote

Direct Disc Search

Doing Disc Search by entering the disc number.

1 Enter the disc number

Press the number buttons on the remote.

2 Do Disc Search

Press the [+] or [-] button.

Canceling Direct Disc Search

Press the [▶II] button.



- Input "0" to select disc 10.

Track/File/Disc/Folder Repeat

Replaying the song, disc in the Disc changer or Audio file folder you're listening to.

Press the [REP] button.

Each time the button is pressed, the Repeat Play switches as shown below.

In CD & External disc source

Repeat play	Display
Track Repeat	"TRAC REP"
Disc Repeat (In Disc Changer)	"DISC REP"
OFF	"REP OFF"

In Audio file source

Repeat play	Display
File Repeat	"FILE REP"
Folder Repeat	"FOLD REP"
OFF	"REP OFF"

Scan Play

Playing the first part of each song on the disc or Audio file folder you are listening to and searching for the song you want to listen to.

1 Start Scan Play

Press the [SCAN] button.

"TRAC SCN"/ "FILE SCN"/ "SCAN ON" is displayed.

2 Release it when the song you want to listen to is played

Press the [SCAN] button.

Random Play

Play all the songs on the disc or Audio file folder in random order.

Press the [RDM] button.

Each time the button is pressed, Random Play turns ON and OFF.

When it's ON, "DISC RDM"/ "FOLD RDM"/ "RDM ON" is displayed.



- When the Control knob is pushed to [▶▶], the next random song starts.

Function of disc changer

Magazine Random Play

Play the songs on all the discs in the disc changer in random order.

Press the [M.RDM] button.

Each time the button is pressed, the Magazine Random Play turns ON and OFF.

When it's ON, "MGZN RDM" is displayed.



- When the Control knob is pushed to [▶▶], the next random song starts.

Function of the KDC-X589

Function of Audio file

Disc Random Play

Playing randomly from all of the Audio files recorded in the disc.

Press the [RDM] button for at least 1 second.

When it's ON, "DISC RDM" is displayed.

Canceling the Disc Random Play

Press the [RDM] button.



- When the Control knob is pushed to [▶▶], the next random song starts.

CD/Audio file/External disc control features

Function of Audio file

Folder Select

Quickly selecting the folder you want to listen to.

1 Enter Folder Select mode

Press the [F.SEL] button.

"F-SELECT" is displayed.

During Select mode the folder information is displayed as shown below.

Folder name display

Displays the current folder name.

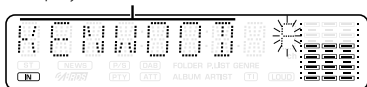

- It doesn't function when <Disc Random Play> (page 19) is ON.

2 Select the folder level*

Push the Control knob to [FM] or [AM].

With the [FM] of the Control knob, you move 1 level down and with the [AM] of the Control knob 1 level up.

Selecting a folder in the same level

Push the Control knob to [◀◀] or [▶▶].

With the [◀◀] of the Control knob, you move to the previous folder, and with the [▶▶] of the Control knob to the next folder.

Returning to the top level*

Press the [3] button.



- * You can operate when <Switching the Play mode> (page 20) is set to "FOLDER" while playing ACDrive disc. (KDC-X589 only)

3 Decide the folder to play

Press the Control knob.

The Folder Select mode releases, and the Audio file in the folder being displayed is played.

Canceling the Folder Select mode

Press the [F.SEL] button.

Function of the KDC-X589

Function of ACDrive disc

Switching the Play mode

Arrange the playing orders of the songs by categories.

Press the [S.MODE] button.

Each time the button is pressed, the Play mode switches as follows.

The play mode indicator is ON.

Play mode	Category which is to be arranged
"P.LIST"	Play list order.
"GENRE"	By genre.
"ARTIST"	By artist.
"ALBUM"	By album.
"FOLDER"	By the folder recorded in Disc.



- The category information of each song is the data registered in Media Manager when ACDrive disc is being generated.
- The announcement when the mode is switched can be canceled by <Voice Index> (page 28).
- The advancement of the play mode information can be selected by [AM] and [FM] keys.

Function of the KDC-X589
Function of the ACDrive disc

Letter Seek

The song, in which you want to play, can be searched by selecting the initial of Genre name, Artist name, or Album name.

1 Enter the Letter Seek mode

Press the [S.MODE] button for at least 1 second.



- It doesn't function when <Disc Random Play> (page 19) is ON.
- This function is available only when the Play mode is set Genre, Artist, or Album.

Canceling the Letter Seek

Press the [S.MODE] button.

2 Start the Letter Seek

Push the Control knob to [◀◀] or [▶▶].

The initial of Genre name, Artist name, or Album name is displayed and read out by the order.



- The announcement of the initial can be canceled by <Voice Index> (page28).
- When the Control knob is pushed to the reverse of [◀◀] or [▶▶] while Letter Seek, the initial is displayed and read by the reversed order.
- When the Letter Seek is started, it cannot be cancelled.

3 Select the song to play

Press the Control knob when the initial of the song you are searching is displayed and read.

The selected initial group plays.



- The category with marks or letters that cannot be read cannot be selected.

Text/Title Scroll

Scrolling the displayed CD text, Audio file text, or MD title.

Hold down on [FM] of the Control knob for at least 1 second.

HD Radio control features

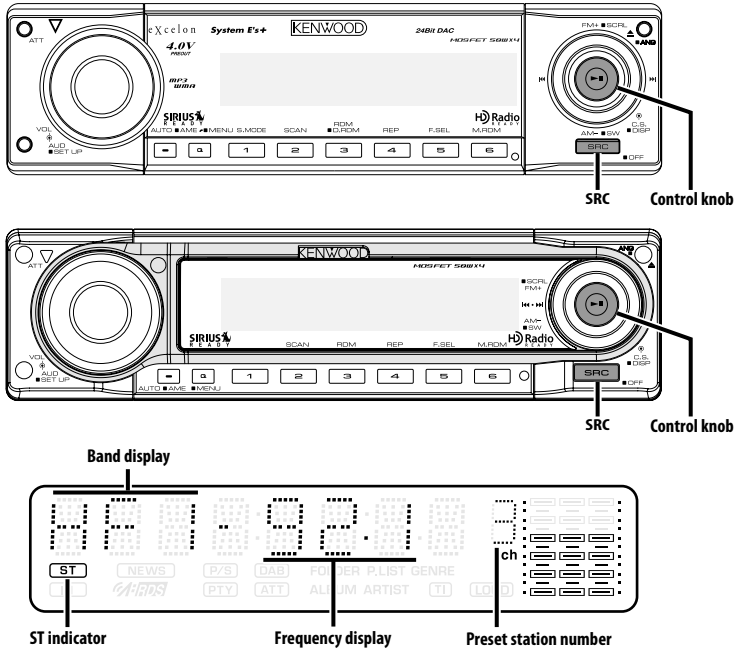

- When you connect an HD Radio, Tuner features of the unit are disabled and switched to HD Radio tuner features. A portion of the setting methods including the Tuning Mode will change.
- With the HD Radio tuner, you can use the similar functions to <Station Preset Memory>, <Auto Memory Entry>, and <Preset Tuning> of Tuner features. Refer to Tuner features for how to use the functions.

Tuning

Selecting the station.

1 Select HD Radio source
Press the [SRC] button.

Select the "HD RADIO" display.

2 Select the HD FM band
Push the Control knob to [FM].

Each time the knob is pushed to [FM], it switches between the HF1, HF2, and HF3 bands.

Select the HD AM band
Push the Control knob to [AM].

3 Tune up or down band
Push the Control knob to [◀◀] or [▶▶].

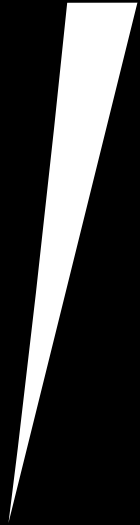

1



Menu system

In Standby mode

Security Code

Because authorization by the Security Code is required when it's removed from the vehicle, personalizing this unit is by using the Security Code is a help in preventing theft.



- The setup Security Code can be done when the <Demonstration mode Setting> (page 29) is set as OFF.
- When the Security Code function is activated, the code can't be changed and the function can't be released. Note, the Security Code can be set as the 4 digit number of your choice.

1 Enter Standby

Press the [SRC] button.

Select the "STANDBY" display.

2 Enter Menu mode

Press the [MENU] button for at least 1 second.

When "MENU" is displayed, "SECURITY" is displayed.

3 Enter Security Code mode

Press the Control knob for at least 1 second.

When "ENTER" is displayed, "CODE" is displayed.

4 Select the digits to enter

Push the Control knob to [◀◀] or [▶▶].

5 Select the Security Code numbers

Push the Control knob to [FM] or [AM].

6 Repeat steps 4 and 5, and complete the Security Code.

7 Confirm the Security Code

Press the Control knob for at least 3 seconds.

When "RE-ENTER" is displayed, "CODE" is displayed.

8 Do the step 4 through 7 operation, and reenter the Security Code.

"APPROVED" is displayed.

The Security Code function activates.



- When the wrong Code is entered in steps 4 through 6, repeat from step 4.

Press the Reset button and when it's removed from the battery power source

1 Turn the power ON.

2 Do the step 4 through 7 operation, and enter the Security Code.

"APPROVED" is displayed.

The unit can be used.

In Standby mode

Touch Sensor Tone

Setting the operation check sound (beep sound) ON/OFF.

Display	Setting
"BEEP ON"	Beep is heard.
"BEEP OFF"	Beep canceled.

In Standby mode

Manual Clock Adjustment

1 Select Clock Adjustment mode

Push the Control knob to [FM] or [AM].

Select the "CLK ADJ" display.

2 Enter Clock Adjust mode

Press the Control knob for at least 1 second.

The clock display blinks.

3 Adjust the hours

Push the Control knob to [FM] or [AM].

Adjust the minutes

Push the Control knob to [◀◀] or [▶▶].

4 Exit Clock adjustment mode

Press the [MENU] button.

In Standby mode

DSI (Disabled System Indicator)

A red indicator will blink on the unit after the faceplate is removed, warning potential thieves.

Display	Setting
"DSI ON"	LED flashes.
"DSI OFF"	LED OFF.

In Standby mode

Selectable Illumination

Selecting the button illumination color as green or red.

Display	Setting
"KEY RED"	The illumination color is red.
"KEY GRN"	The illumination color is green.

In Standby mode

Dimmer

Dimming this unit's display automatically when the vehicle light switch is turned ON.

Display	Setting
"DIM ON"	The display dims.
"DIM OFF"	The display doesn't dim.

*Function of the KDC-MP5028/KDC-MP528
In Standby mode*

Switching preout

Switching the preout between the rear and subwoofer. (In subwoofer it outputs without effect from the fader control.)

Display	Setting
"SWPRE R"	Rear preout.
"SWPRE SW"	Subwoofer preout.

In Standby mode

Built-in Amp Setting

Built-in amplifier is controlled.
Turning OFF this control enhances the preout quality.

Display	Setting
"AMP ON"	The built-in amplifier activates.
"AMP OFF"	The built-in amplifier deactivates.

*Other than Standby mode/
When the Dual Zone System is ON*

Dual Zone System Setting

Setting the Front channel and Rear channel sound in the Dual Zone System.

Display	Setting
"ZONE2 R"	Sub source (Auxiliary input source) is to be rear channel.
"ZONE2 F"	Sub source (Auxiliary input source) is to be front channel.

*Function of the KDC-X589
Other than Standby mode*

B.M.S. (Bass Management System)

Adjust the bass boost level of the external amplifier using the main unit.

Display	Setting
"BMS FLT"	Bass boost level is flat.
"BMS +6"	Bass boost level is low (+6dB).
"BMS +12"	Bass boost level is mid (+12dB).
"BMS +18"	Bass boost level is high (+18dB).



- Refer to the catalog or instruction manual for power amplifiers that can be controlled from this unit.
- For amplifiers there are the model that can be set from Flat to +18 dB, and the model that can be set from Flat to +12 dB.
When an amplifier that can only be set to +12 is connected to the unit, "BMS +18" won't work correctly even if it's selected.

*Function of the KDC-X589
Other than Standby mode*

B.M.S. Frequency Offset

Setting the central frequency boosted by B.M.S.

Display	Setting
"BMSF NML"	Boost with the normal central frequency.
"BMSF LOW"	Drop the normal central frequency 20%.

Menu system

Function of the KDC-X589
When LX AMP unit connecting

AMP Control

You can control the LX AMP connected to the unit.

1 Select AMP Control mode

Push the Control knob to [FM] or [AM].

Select the "AMS CTRL" display.

2 Enter AMP Control mode

Press the Control knob for at least 1 second.

3 Select the AMP Control item for adjustment

Push the Control knob to [FM] or [AM].



- For the details of the AMP Control item, see the Instruction manual attached to the LX AMP.

4 Adjust the AMP Control item

Push the Control knob to [◀◀] or [▶▶].

5 Exit AMP Control mode

Press the [MENU] button.



- You cannot use the LX AMP operation during standby mode.

In FM reception

CRSC (Clean Reception System Circuit)

Temporarily have reception switched from stereo to mono to reduce multi-path noise when listening to the FM station.

Display	Setting
"CRSC ON"	The CRSC is ON.
"CRSC OFF"	The CRSC is OFF.



- Strong electrical fields (such as from power lines) may cause unstable sound quality when CRSC is turned ON. In such a situation, turn it OFF.

In HD Radio mode

Receive mode Setting

Sets the receive mode.

1 Select the Receive mode

Push the Control knob to [FM] or [AM].

Select the "HDR MODE" display.

2 Enter Receive mode

Press the Control knob for at least 1 second.

3 Set the Receive mode

Push the Control knob to [FM] or [AM].

Each time the knob is pushed, the Receive mode switches as shown below.

Receive mode	Display	Operation
Auto mode	"AUTO"	Analog broadcasts and digital broadcasts will be switched automatically. When both are being transmitted, the digital broadcast will have priority.
Digital	"DIGITAL"	Digital broadcasts only.
Analog	"ANALOG"	Analog broadcasts only.

4 Exit Receive mode

Press the [MENU] button.



- Even if the "AUTO" setting, and analog broadcast will be received during the reception of a ball game mode (non-delayed broadcast program).

In SIRIUS tuner source

SIRIUS ID (ESN) display

Displaying the SIRIUS ID (Electronic Serial Number)

Display
"ESN=*****"



• Serial & SIRIUS ID (ESN)

It is especially important to retain the unit serial number and the electronic SIRIUS Identification number for service activation and potential future service changes.

Auxiliary Input Display Setting & Station/Disc Naming

For selecting the display when switched to Auxiliary input source. For the Station/Disc Naming refer to the <Station/Disc Naming (SNPS/DNPS)> (page 13).

1 Select Auxiliary input source

Press the [SRC] button.

Select the "AUX**"/ "AUX EXT" display.

2 Enter Menu mode

Press the [MENU] button for at least 1 second.

"MENU" is displayed.

3 Select Auxiliary input display setting mode

Push the Control knob to [FM] or [AM].

Select the "NAME SET" display.

4 Enter Auxiliary input display setting mode

Press the Control knob for at least 1 second.

The presently selected Auxiliary input display is displayed.

5 Select the Auxiliary input display

Push the Control knob to [◀◀] or [▶▶].

Each time the button is pressed, the display switches as shown below.

- "AUX**"/ "AUX EXT"
- "DVD"
- "PORTABLE"
- "GAME"
- "VIDEO"
- "TV"

6 Exit Auxiliary input display setting mode

Press the [MENU] button.



- When operation stops for 10 seconds, the name at that time is registered, and the Auxiliary input display setting mode closes.
- The Auxiliary Input Display can be set only when the built-in auxiliary input or the auxiliary input of optional KCA-S210A is used.
- * KDC-MP5028/MP528 only.

Text Scroll

Setting the displayed text scroll.

Display	Setting
"SCL AUTO"	Repeats scroll.
"SCL MANU"	Scrolls when the display changes.



- The text scrolled is shown below.
 - CD text
 - Folder name/ File name/ Song title/ Artist name/ Album name
 - MD title
 - Text for the SIRIUS tuner source, HD Radio source, including Channel name, etc.

Function of the KDC-MP5028/KDC-MP528 In Standby mode

Built-in Auxiliary input Setting

Set the Built-in Auxiliary Input function.

Display	Setting
"AUX OFF"	When selecting the source there's no Auxiliary Input.
"AUX ON"	When selecting the source there's Auxiliary Input.

In Standby mode

CD Read Setting

When there is a problem on playing a CD with special format, this setting play the CD by force.

Display	Setting
"CD READ1"	Play CD and Audio file.
"CD READ2"	Play CD by force.



- Setting "CD READ2" cannot play Audio file. Some music CDs may not be played back even in the "CD READ2" mode.

Menu system

Function of the KDC-X589
Function of ACDrive disc

Voice Index

Setting the announcement during the play of ACDrive disc.

Display	Setting
"V-ID ON"	Guide is announced.
"V-ID OFF"	Not be announced.

Function of the KDC-X589
In CD mode

ACDrive firmware version display

Displaying the firmware version with the ACDrive function.

- 1 Select the firmware version display mode**
Push the Control knob to [FM] or [AM].
Select the "ACD.VER" display.
- 2 Display the ACDrive firmware version**
Push the Control knob to [◀◀] or [▶▶].

Function of the KDC-X589
In CD mode

Unique ID display

Displaying the serial number for each product.

- 1 Select the unique ID display mode**
Push the Control knob to [FM] or [AM].
Select the "ACD ID" display.
- 2 Display the unique ID**
Push the Control knob to [◀◀] or [▶▶].

Audio Preset Memory

Registering the value setup by Sound Control. The memory can't be erased by the Reset button.

1 Setup Sound Control

Refer to the following operations to setup the Sound Control.

- <Audio Control> (page 10)
- <Audio Setup> (page 11)

2 Enter Menu mode

Press the [MENU] button for at least 1 second.
"MENU" is displayed.

3 Select Audio Preset mode

Push the Control knob to [FM] or [AM].
Select the "A-PRESET" display.

4 Enter Audio Preset mode

Press the Control knob for at least 1 second.

5 Select the Audio Preset Memory

Push the Control knob to [FM] or [AM].
Select the "MEMORY" display.

6 Put the Audio Preset in the memory

Press the Control knob for at least 2 seconds.
The "MEMORY" display blinks 1 time.

7 Exit Menu mode

Press the [MENU] button.



- Register 1 pair of Audio Preset Memory. You can't register by the source.
- When you press the Reset, all the sources will be the setting value which is registered.
- The following items can't be registered.
Volume, Balance, Fader, Loudness, Volume offset, Dual Zone System, Rear Volume

Audio Preset Call

Recalling the sound setup registered by <Audio Preset Memory> (page 28).

1 Select the source

Press the [SRC] button.

2 Enter Menu mode

Press the [MENU] button for at least 1 second.
"MENU" is displayed.

3 Select Audio Preset mode

Push the Control knob to [FM] or [AM].
Select the "A-PRESET" display.

4 Enter Audio Preset mode

Press the Control knob for at least 1 second.

5 Select the Audio Preset Call

Push the Control knob to [FM] or [AM].
Select the "CALL" display.

6 Call up the Audio Preset

Press the Control knob for at least 2 seconds.
The "CALL" display blinks 1 time.

7 Exit Menu mode

Press the [MENU] button.



- The User memory of <System Q> (page 10) is changed to the value which was recalled.
- The source tone memory item of <Audio Control> (page 10) is changed to the value which was recalled by the selected source.

In Standby mode

Demonstration mode Setting

Sets the demonstration mode.

1 Select the Demonstration mode

Push the Control knob to [FM] or [AM].
Select the "DEMO" display.

2 Set the Demonstration mode

Press the Control knob for at least 2 seconds.
Each time the knob is pressed at least 2 seconds, the Demonstration mode switches as shown below.

Display	Setting
"DEMO ON"	The Demonstration mode function is ON.
"DEMO OFF"	Exit Demonstration mode (Normal mode).

Basic Operations of remote

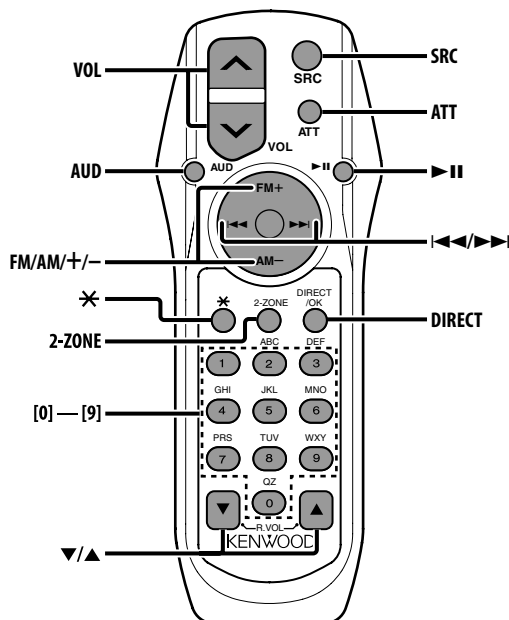

Loading and Replacing the battery

Use two "AA"-size batteries.

Slide the cover while pressing downwards to remove it as illustrated.

Insert the batteries with the + and - poles aligned properly, following the illustration inside the case.

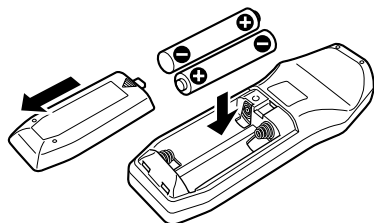

▲WARNING

- Store unused batteries out of the reach of children. Contact a doctor immediately if the battery is accidentally swallowed.



- Do not set the remote on hot places such as above the dashboard.

Basic operations

[VOL] buttons

Adjusting the volume.

[SRC] button

Each time the button is pressed, the source switches.

For the source switching order refer to <Selecting the Source> (page 9).

[ATT] button

Turning the volume down quickly.

When it is pressed again, it returns to the previous level.

[*] button

Adjusting the Faceplate Angle.

Audio Control

[AUD] button

Select the Audio item for adjustment.

[VOL] buttons

Adjust the Audio item.



- Refer to <Audio Control> (page 10) for the operation method, such as the procedures of Audio control and others.
- Only selecting and adjusting of the Basic Audio item can be done by the remote control. Selecting and adjusting of the Detail Audio item cannot be done.

Dual Zone System

[2-ZONE] button

Each time the button is pressed, "2ZON" of <Audio Setup> (page 11) is turned ON and OFF.

[▲]/ [▼] buttons

Adjusts the volume of the rear channel.
It activates while the Dual Zone System is ON.

In Tuner source

[FM]/ [AM] buttons

Select the band.
Each time the [FM] button is pressed, it switches between the FM1, FM2, and FM3 bands.

[◀◀]/ [▶▶] buttons

Tune up or down band.

[0] — [9] buttons

Press buttons [1] — [6] to recall preset stations.

[DIRECT] button

Enters and cancels the <Direct Access Tuning> (page 16) mode.

In Disc source

[◀◀]/ [▶▶] buttons

Doing track/file forward and backward.

[+]/ [-] buttons

Doing disc/folder forward and backward.

[▶ II] button

Each time the button is pressed, the song pauses and plays.

[0] — [9] buttons

When in <Direct Track/File Search> (page 18) and <Direct Disc Search> (page 18), enter the track/file/disc number.

In SIRIUS tuner source

[FM] button

Select the preset band.

[◀◀]/ [▶▶] buttons

Search up or down channel.

[0] — [9] buttons

Press buttons [1] — [6] to recall preset channels.

[DIRECT] button

Enters and cancels the <Direct Access Tuning> mode.



- Refer to the instruction manual of SIRIUS Satellite radio tuner for <Direct Access Tuning> function.

In HD Radio source

[FM] button

Select the HD FM band.
Each time the [FM] button is pressed, it switches between the HF1, HF2, and HF3 bands.

[AM] button

Select the HD AM band.

[◀◀]/ [▶▶] buttons

Tune up or down band.

[0] — [9] buttons

Press buttons [1] — [6] to recall preset stations.

Accessories/ Installation Procedure

Accessories

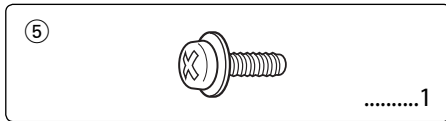
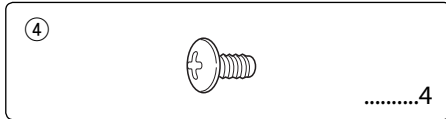
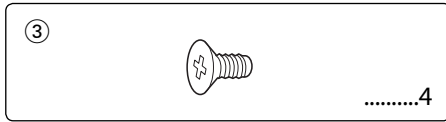
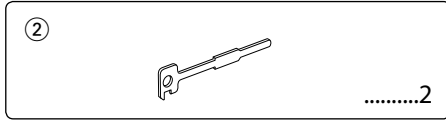
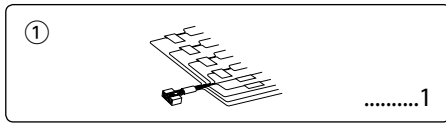

Installation Procedure

1. To prevent a short circuit, remove the key from the ignition and disconnect the ⊖ battery.
2. Make the proper input and output wire connections for each unit.
3. Connect the speaker wires of the wiring harness.
4. Connect the wiring harness wires in the following order: ground, battery, ignition.
5. Connect the wiring harness connector to the unit.
6. Install the unit in your car.
7. Reconnect the ⊖ battery.
8. Press the reset button.

▲WARNING

If you connect the ignition wire (red) and the battery wire (yellow) to the car chassis (ground), you may cause a short circuit, that in turn may start a fire. Always connect those wires to the power source running through the fuse box.



- If the power is not turned ON (or it is ON, but will be OFF immediately), the speaker wire may have a short-circuit or touched the chassis of the vehicle and the protection function may have been activated. Therefore, the speaker wire should be checked.
- If your car's ignition does not have an ACC position, connect the ignition wires to a power source that can be turned on and off with the ignition key. If you connect the ignition wire to a power source with a constant voltage supply, as with battery wires, the battery may die.
- If the console has a lid, make sure to install the unit so that the faceplate will not hit the lid when closing and opening.
- If the fuse blows, first make sure the wires aren't touching to cause a short circuit, then replace the old fuse with one with the same rating.
- Insulate unconnected wires with vinyl tape or other similar material. To prevent a short circuit, do not remove the caps on the ends of the unconnected wires or the terminals.
- Connect the speaker wires correctly to the terminals to which they correspond. The unit may be damaged or fail to work if you share the ⊖ wires or ground them to any metal part in the car.
- When only two speakers are being connected to the system, connect the connectors either to both the front output terminals or to both the rear output terminals (do not mix front and rear). For example, if you connect the ⊕ connector of the left speaker to a front output terminal, do not connect the ⊖ connector to a rear output terminal.
- After the unit is installed, check whether the brake lamps, blinkers, wipers, etc. on the car are working properly.
- Mount the unit so that the mounting angle is 30° or less.

Connecting Wires to Terminals

	KDC-X589	KDC-MP5028/MP528
A	Front left output (White)	Front left output (White)
	Front right output (Red)	Front right output (Red)
B	Rear left output (White)	Rear left output (White)/ Sub Woofer left output (White)
	Rear right output (Red)	Rear right output (Red)/ Sub Woofer right output (Red)
C	Sub Woofer left output (White)	AUX left input (White)
	Sub Woofer right output (Red)	AUX right input (Red)

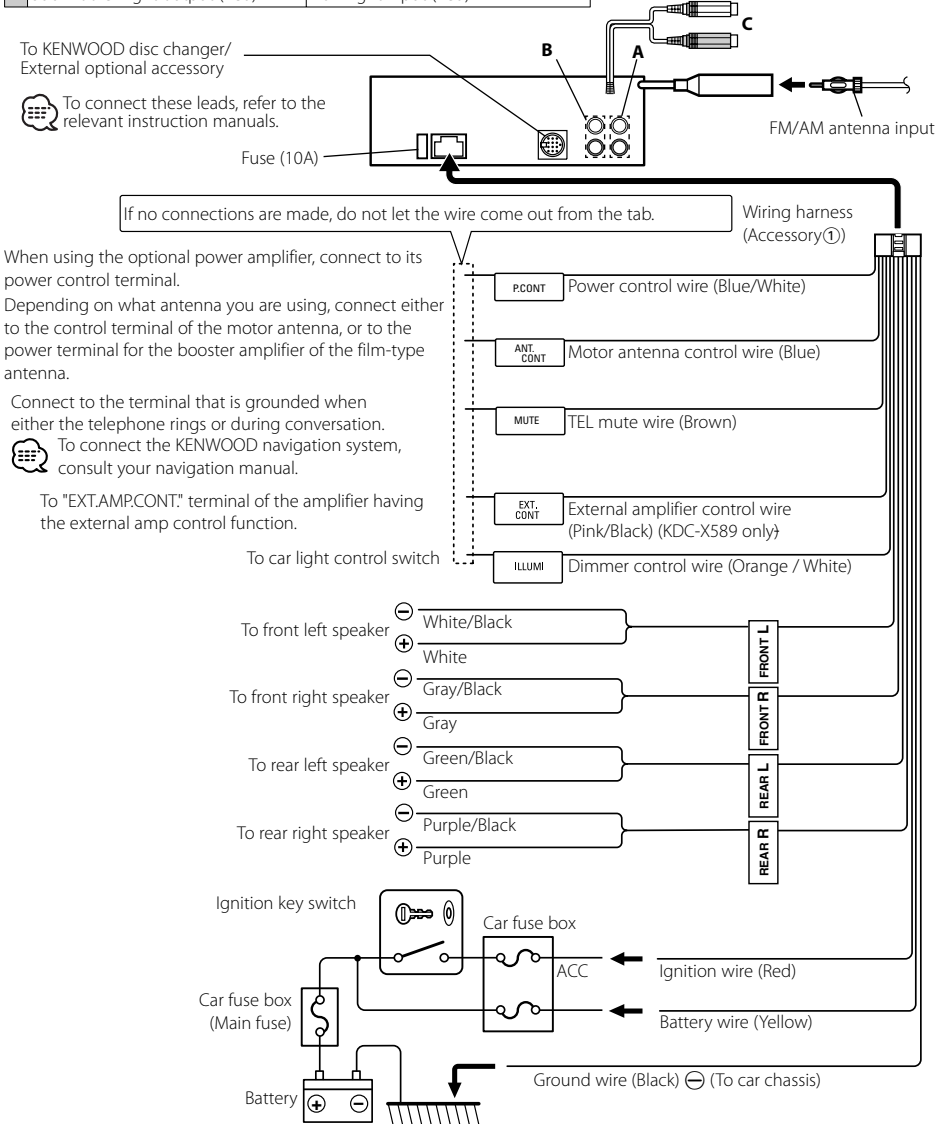

Installation

non-Japanese cars

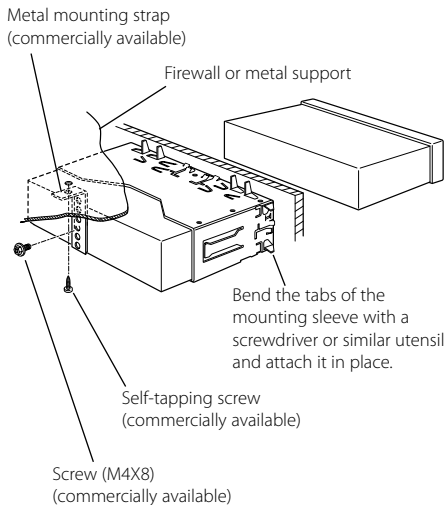

- Make sure that the unit is installed securely in place. If the unit is unstable, it may malfunction (for example, the sound may skip).

Japanese cars

- 1 Refer to the section <Removing the hard rubber frame> (page 36) and then remove the hard rubber frame.
- 2 Align the holes in the unit (two locations on each side) with the vehicle mounting bracket and secure the unit with the accessory screws.

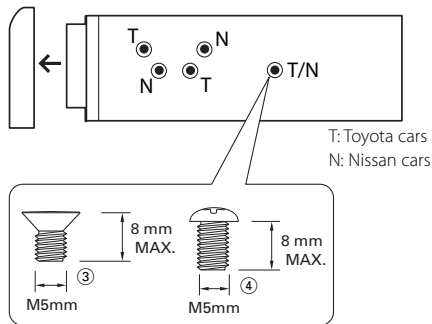

- During installation, do not use any screws except for those provided. The use of different screws might result in damage to the main unit.
- Damage may occur if a screwdriver or similar tool is used with excessive force during the installations.

Screwing the Faceplate on the Unit

If you want to fasten the faceplate to the main unit so that it does not fall off, screw in the provided screws in the holes shown below.

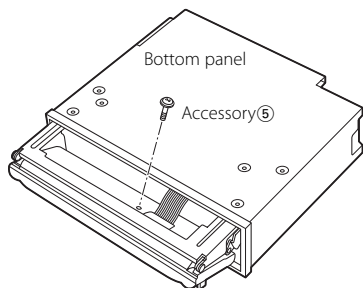

- Never insert the screw in any other screw hole than the one specified. If you screw them in another hole, it will contact and may cause damage to the mechanical parts inside the unit.

Removing the Unit

Removing the hard rubber frame

- 1 Engage the catch pins on the removal tool and remove the two locks on the upper level. Upper the frame and pull it forward as shown in the figure.

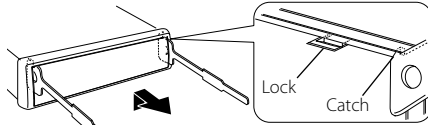

Accessory②
Removal tool

- 2 When the upper level is removed, remove the lower two locations.

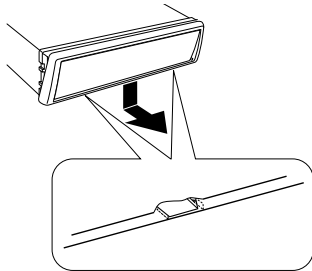

- The frame can be removed from the bottom side in the same manner.

Removing the Unit

- 1 Refer to the section <Removing the hard rubber frame> (page 36) and then remove the hard rubber frame.
- 2 Remove the screw (M4 × 8) on the back panel.
- 3 Insert the two removal tools deeply into the slots on each side, as shown.

Screw (M4X8)
(commercially available)

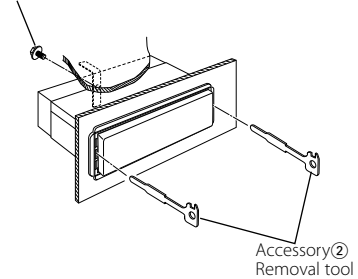

- 4 Lower the removal tool toward the bottom, and pull out the unit halfway while pressing towards the inside.

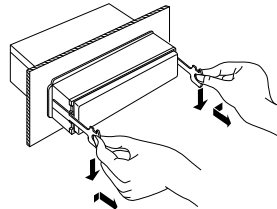

- Be careful to avoid injury from the catch pins on the removal tool.
- 5 Pull the unit all the way out with your hands, being careful not to drop it.

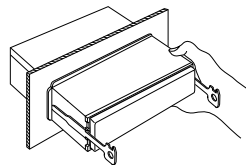

Troubleshooting Guide

What might seem to be a malfunction in your unit may just be the result of slight misoperation or miswiring. Before calling service, first check the following table for possible problems.

General

? The power does not turn ON.

- ✓ The fuse has blown.
 - ☞ After checking for short circuits in the wires, replace the fuse with one with the same rating.
- ✓ The speaker wire has a short-circuit or touches the chassis of the vehicle, and then the protection function is activated.
 - ☞ Wire or insulate the speaker cable properly and press the reset button.

? There's a source you can't switch.

- ✓ There's no media inserted.
 - ☞ Set the media you want to listen to. If there's no media in this unit, you can't switch to each source.
- ✓ The Disc changer isn't connected.
 - ☞ Connect the Disc changer. If the Disc changer isn't connected to its input terminal, You can't switch to an external disc source.

? The memory is erased when the ignition is turned OFF.

- ✓ The ignition and battery wire are incorrectly connected.
 - ☞ Connect the wire correctly, referring to the section on <Connecting Wires to Terminals>.

? The TEL mute function does not work.

- ✓ The TEL mute wire is not connected properly.
 - ☞ Connect the wire correctly, referring to the section on <Connecting Wires to Terminals>.

? The TEL mute function turns ON even though the TEL mute wire is not connected.

- ✓ The TEL mute wire is touching a metal part of the car.
 - ☞ Pull the TEL mute wire away from the metal part of the car.

? Even if Loudness is turned ON, high-pitched tone isn't compensated for.

- ✓ Tuner source is selected.
 - ☞ High-pitched tone isn't compensated for when in Tuner source.

? No sound can be heard, or the volume is low.

- ✓ The fader or balance settings are set all the way to one side.
 - ☞ Center the fader and balance settings.
- ✓ The input/output wires or wiring harness are connected incorrectly.
 - ☞ Reconnect the input/output wires or the wiring harness correctly. See the section on <Connecting Wires to Terminals>.
- ✓ The values of Volume offset are low.
 - ☞ Turn up the Volume offset, referring to the section on <Audio Control> (page 10).
- ✓ The <Built-in Amp Setting> (page 25) is OFF.
 - ☞ Turn it ON.

? The sound quality is poor or distorted.

- ✓ One of the speaker wires is being pinched by a screw in the car.
 - ☞ Check the speaker wiring.
- ✓ The speakers are not wired correctly.
 - ☞ Reconnect the speaker wires so that each output terminal is connected to a different speaker.

? The Touch Sensor Tone doesn't sound.

- ✓ The preout jack is being used.
 - ☞ The Touch Sensor Tone can't be output from the preout jack.

? The Dimmer function doesn't work.

- ✓ The Dimmer wire isn't connected correctly.
 - ☞ Check the Dimmer wire connection.
- ✓ The <Dimmer> (page 25) is OFF.
 - ☞ Turn it ON.

? The sound is not output from Subwoofer or it outputs the different sound.

- ✓ When "2ZON" of <Audio Setup> (page 11) is set to ON.
 - ☞ Turn OFF "2ZON".

Tuner source

? Radio reception is poor.

- ✓ The car antenna is not extended.
 - ☞ Pull the antenna out all the way.
- ✓ The antenna control wire is not connected.
 - ☞ Connect the wire correctly, referring to the section on <Connecting Wires to Terminals>.

? The desired frequency can't be entered with the Direct Access Tuning.

- ✓ A station that can't be received is being entered.
 - ☞ Enter a station that can be received.
- ✓ You're trying to enter a frequency with a 0.01 MHz unit.
 - ☞ What can be designated in the FM band is to 0.1 MHz.

Disc source

? "AUX EXT" is displayed without achieving External disc control mode.

- ✓ Unsupported disc changer is connected.
 - ☞ Use the disc changer mentioned in the <About CD players/disc changers connected to this unit> (page 4) of the section on <Safety precautions>.

? The specified disc does not play, but another one plays instead.

- ✓ The specified CD is quite dirty.
 - ☞ Clean the CD.
- ✓ The disc is loaded in a different slot from that specified.
 - ☞ Eject the disc magazine and check the number for the specified disc.
- ✓ The disc is severely scratched.
 - ☞ Try another disc instead.

? Can't remove disc.

- ✓ The cause is that more than 10 minutes has elapsed since the vehicle ACC switch was turned OFF.
 - ☞ The disc can only be removed within 10 minutes of the ACC switch being turned OFF. If more than 10 minutes has elapsed, turn the ACC switch ON again and press the Eject button.

? The disc won't insert.

- ✓ There's already another disc inserted.
 - ☞ Press the [▲] button and remove the disc.

? Direct Search can't be done.

- ✓ Another function is ON.
 - ☞ Turn Random Play or other functions OFF.

? Track Search can't be done.

- ✓ For the discs/folders first or last song.
 - ☞ For each disc/folder, Track Search can't be done in the backward direction for the first song or in the forward direction for the last song.

Audio file source

? Cannot play an Audio file.

- ✓ The media is scratched or dirty.
 - ☞ Clean the media, referring to the CD cleaning of the section on <About CDs> (page 7).

? The sound skips when an Audio file is being played.

- ✓ The media is scratched or dirty.
 - ☞ Clean the media, referring to the CD cleaning of the section on <About CDs> (page 7).
- ✓ The recording condition is bad.
 - ☞ Record the media again or use another media.

? The Audio file track time isn't displayed correctly.

- ✓ ---
 - ☞ There are times when it isn't displayed correctly according to the Audio file recording conditions.

HD Radio source

? No sound can be heard, or the volume is low.

- ✓ The preset broadcast station is not transmitting in the mode that was set with <Receive mode Setting> (page 26).
 - ☞ Please set <Receive mode Setting> to "AUTO".
- ✓ In digital AM broadcasting, receive mode switches between stereo and monaural too often.
 - ☞ Receiving condition is bad or unstable. Stereo is chosen when receiving condition is good, and it switches to monaural when the condition becomes bad.
- ✓ HD Radio tuner is connected to KCA-S210A or other units.
 - ☞ Connect the HD Radio tuner directly to the control unit.

The messages shown below display your systems condition.

EJECT:	No disc magazine has been loaded in the changer. The disc magazine is not completely loaded. ↻ Load the disc magazine properly. No CD in the unit. ↻ Insert the CD.
NO DISC:	No disc has been loaded in the disc magazine. ↻ Load a disc into the disc magazine.
TOC ERR:	No disc has been loaded in the disc magazine. ↻ Load a disc into the disc magazine. The CD is quite dirty. The CD is upside-down. The CD is scratched a lot. ↻ Clean the CD and load it correctly.
E-05:	The CD is upside-down. ↻ Load the CD correctly.
BLANK:	Nothing has been recorded on the MD.
NO TRACK:	No tracks are recorded on the MD, although it has a title.
E-15:	Media was played that doesn't have data recorded that the unit can play. ↻ Use media that has data recorded that the unit can play.
NO PANEL:	The faceplate of the slave unit being connected to this unit has been removed. ↻ Replace it.
E-77:	The unit is malfunctioning for some reason. ↻ Press the reset button on the unit. If the "E-77" code does not disappear, consult your nearest service center.
E-99:	Something is wrong with the disc magazine. Or the unit is malfunctioning for some reason. ↻ Check the disc magazine. And then press the reset button on the unit. If the "E-99" code does not disappear, consult your nearest service center.

HOLD:	The protective circuit in the unit activates when the temperature inside the automatic disc changer exceeds 60°C (140°F), stopping all operation. ↻ Cool down the unit by opening the windows or turning on the air conditioner. As the temperature falls below 60°C (140°F), the disc will start playing again.
NO NAME:	Attempted to display DNPS during the CD play having no disc names preset.
LOAD:	Discs are being exchanged in the Disc changer.
READING:	The unit is reading the data on the disc.
IN (Blink):	The CD player section is not operating properly. ↻ Reinsert the CD. If the CD cannot be ejected or the display continues to flash even when the CD has been properly reinserted, please switch off the power and consult your nearest service center.
NA FILE:	An Audio file is played with a format that this unit can't support. ↻ ----
COPY PRO:	A copy-protected file is played. ↻ ----

Specifications

Specifications subject to change without notice.

FM tuner section

Frequency range (200 kHz space)
: 87.9 MHz – 107.9 MHz
Usable sensitivity (S/N = 30dB)
: 9.3dBf (0.8 μ V/75 Ω)
Quieting Sensitivity (S/N = 50dB)
: 15.2dBf (1.6 μ V/75 Ω)
Frequency response (± 3 dB)
: 30 Hz – 15 kHz
Signal to Noise ratio (MONO)
: 70 dB
Selectivity (± 400 kHz)
: ≥ 80 dB
Stereo separation (1 kHz)
: 40 dB

AM tuner section

Frequency range (10 kHz space)
: 530 kHz – 1700 kHz
Usable sensitivity (S/N = 20dB)
: 28 dB μ (25 μ V)

CD player section

Laser diode
: GaAlAs
Digital filter (D/A)
: 8 Times Over Sampling
D/A Converter
: 1 Bit
Spindle speed (Audio file)
: 1000 – 400 rpm (CLV 2times)
Wow & Flutter
: Below Measurable Limit
Frequency response (± 1 dB)
: 10 Hz – 20 kHz
Total harmonic distortion (1 kHz)
KDC-X589: 0.008 %
KDC-MP5028/MP528: 0.01 %
Signal to Noise ratio (1 kHz)
KDC-X589: 110 dB
KDC-MP5028/MP528: 105 dB
Dynamic range
: 93 dB
Channel separation
: 96 dB
MP3 decode
: Compliant with MPEG-1/2 Audio Layer-3
WMA decode
: Compliant with Windows Media Audio
AAC decode
: AAC-LC ".m4a" files

Audio section

Maximum output power
: 50 W x 4
Full Bandwidth Power (at less than 1% THD)
: 22 W x 4
Tone action
Bass : 100 Hz ± 10 dB
Middle : 1 kHz ± 10 dB
Treble : 10 kHz ± 10 dB
Preout level / Load (during disc play)
KDC-X589/MP5028: 4000 mV/10 k Ω
KDC-MP528: 2500 mV/10 k Ω
Preout impedance
: $\leq 600 \Omega$

Auxiliary input (KDC-MP5028/MP528)

Frequency response (± 1 dB)
: 20 Hz – 20 kHz
Input Maximum Voltage
: 1200 mV
Input Impedance
: 100 k Ω

General

Operating voltage (11 – 16V allowable)
: 14.4 V
Current consumption
: 10 A
Installation Size (W x H x D)
: 182 x 53 x 155 mm
7-3/16 x 2-1/16 x 6-1/10 inch
Weight
3.09 lbs (1.4 kg)